

DOMO MALLORQUINA

SISTEMA MALLORQUINA

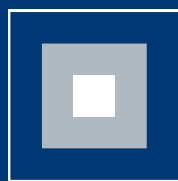

INDALSU

SISTEMAS EN ALUMINIO



CARACTERÍSTICAS

Sistema de lamas fijas y móviles.

Perfiles de extrusión de aleación 6063.

Espesor de perfiles de 1.3 mm y 1.4 mm.

Juntas de estanqueidad en E.P.D.M.

Escuadras de unión de aluminio inyectado con muelle de tetón.

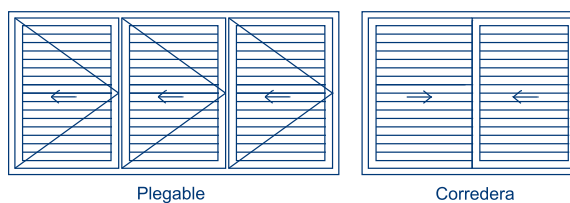
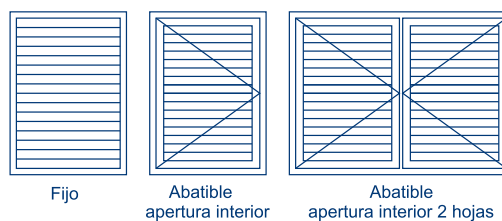
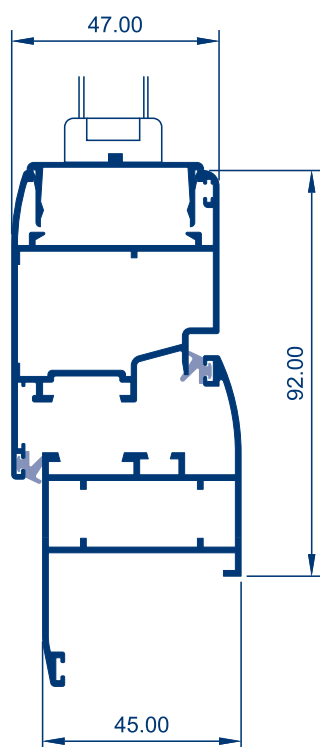



DOMO MALLORQUINA

SISTEMA MALLORQUINA

Referencia	Sección	Designación	Peso g./ ml	Perímetro dm2 / ml.	Inercia Ix cm4	Inercia Iy cm4
210		Lama fija	313	22.0		
211		Lama móvil	513	34.6		
212		Lama compensadora	395	26.7		
2011		Marco recto	659	37.0	5.4932	3.6773
2012		Marco curvo	737	40.8	7.2013	4.4696
2013		Marco curvo con resalte	810	44.8	11.2046	4.7619
2014		Marco recto puerta	745	41.8	6.6811	7.5319
2015		Marco curvo puerta	802	44.4	8.6370	8.7243
2022		Travesaño de 72 mm	813	45.5	6.3427	7.0435
2023		Travesaño de 84 mm	898	50.3	7.5707	12.7711
2046		Inversor recto	845	45.2	6.7711	6.5828
2047		Inversor curvo	899	47.5	8.3394	7.2929
2050		Adaptador	281	17.6	0.4156	1.3014
2052		Hoja ventana	896	50.2	10.2637	9.8550
2054		Zócalo	1267	60.5	13.2156	41.6416
2055		Hoja puerta	1091	54.9	13.3265	18.9327
2062		Marco curvo con solape	845	46.4	9.1780	8.9199
5070		Terminal de lamas	265	16.1	0.3509	1.1773
5111		Hoja corredera	948	45.6	8.6309	12.2969
5334		Hoja plegable para cristal	1050	50.5	9.0265	16.1796
5335		Marco	832	42.0	9.7855	3.8711
5336		Guía superior de empotrar	1199	43.3	12.7863	8.6499
5337		Inversor doble hoja	219	10.7	0.1749	0.3154
5338		Tapa decorativa guía sup. superp	680	34.0	9.4039	19.6815
5340		Guía superior superpuesta	1823	50.8	10.5513	48.8575
5341		Tapa lateral	540	22.8	0.7983	9.9473
5342		Guía inferior empotrada	362	18.0	0.8546	1.8096
5343		Guía inferior superpuesta	567	28.2	1.0116	11.5390

DOMO MALLORQUINA



SISTEMA MALLORQUINA

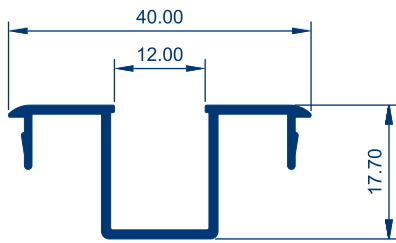

Ref.2050

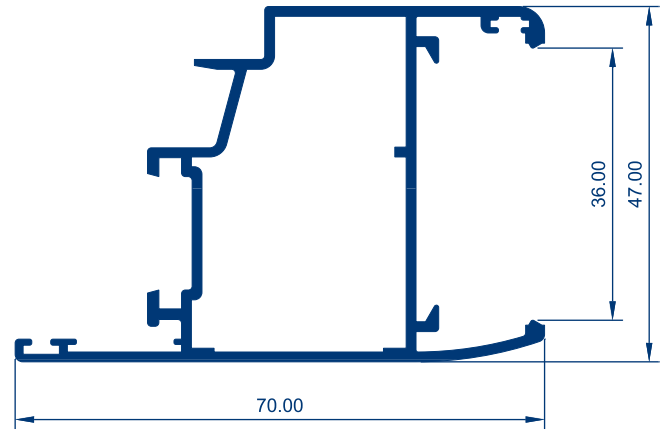

Ref.2052

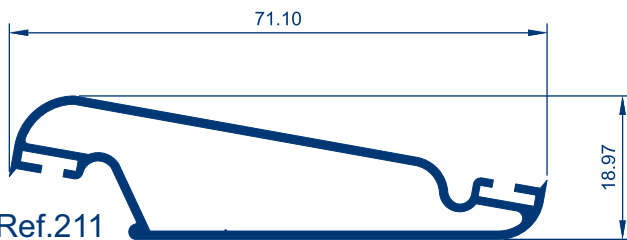

Ref.211

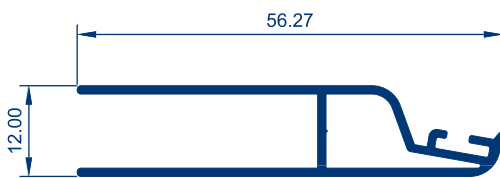

Ref.212

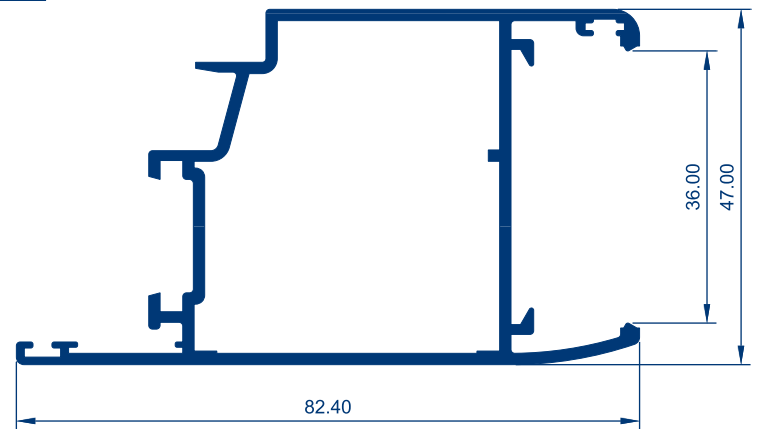

Ref.2055

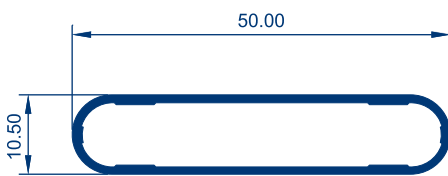

Ref.210

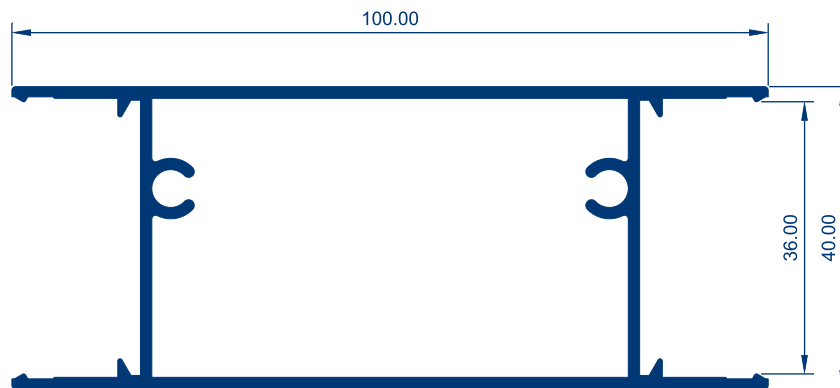

Ref.2054



DOMO MALLORQUINA

SISTEMA MALLORQUINA

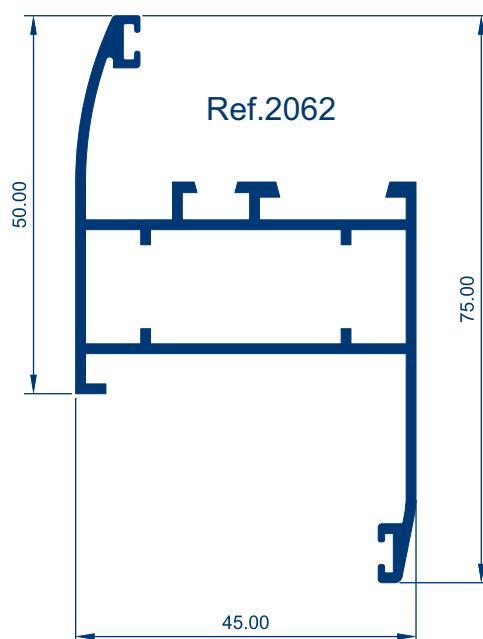
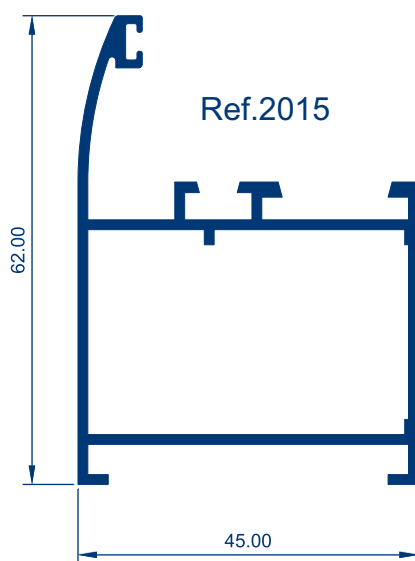
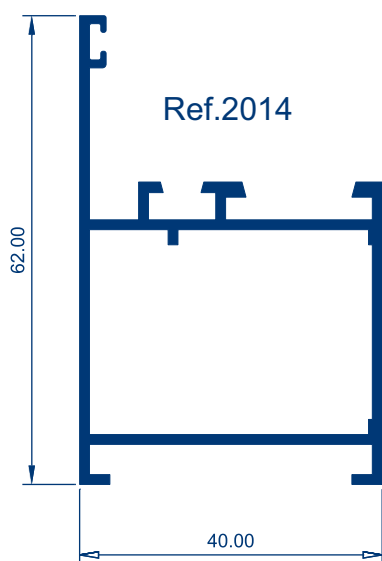
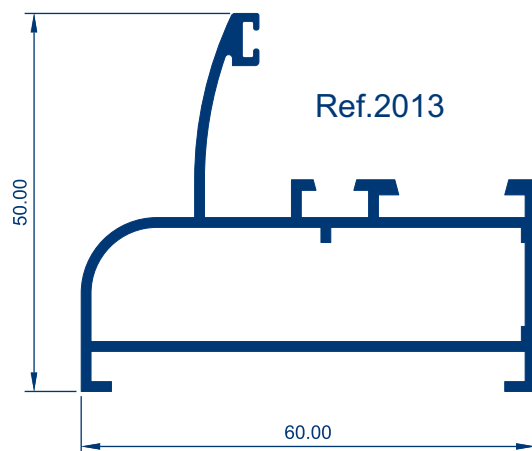
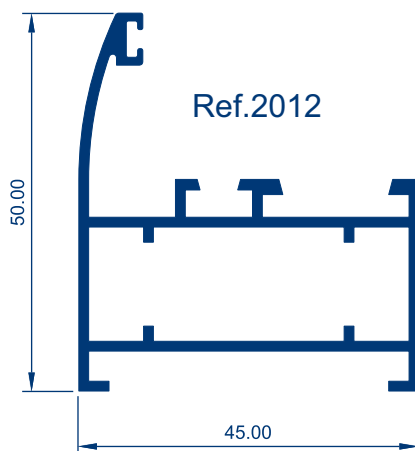
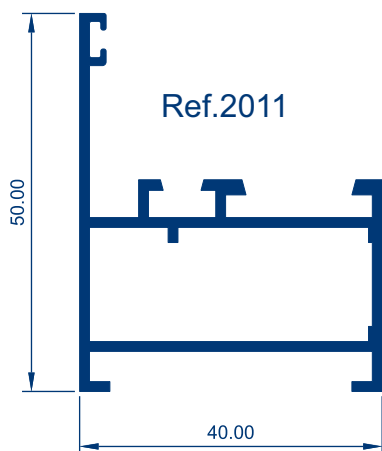

DOMO MALLORQUINA



SISTEMA MALLORQUINA

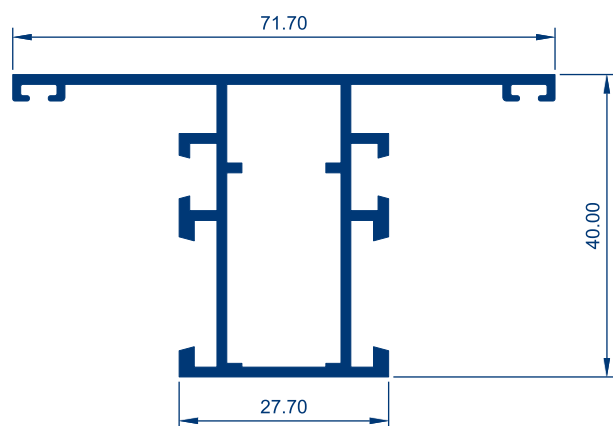

Ref.2022

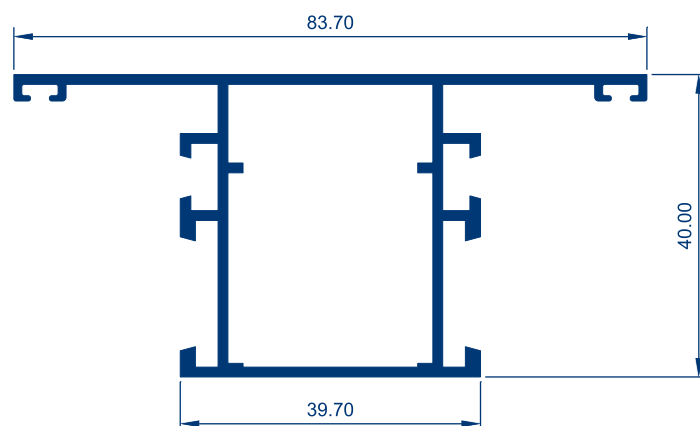

Ref.2023

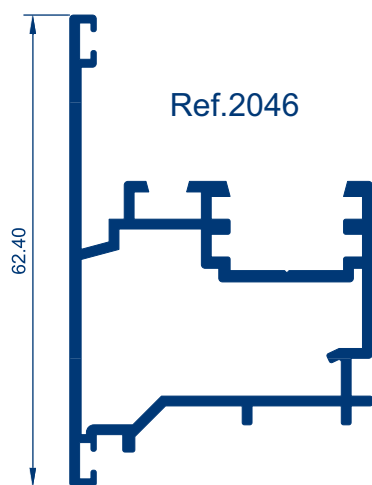

Ref.2046

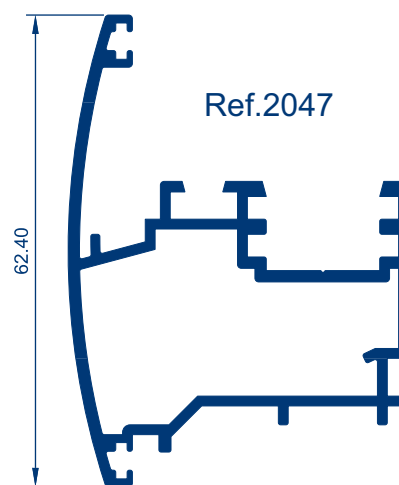

Ref.2047



DOMO MALLORQUINA

SISTEMA MALLORQUINA

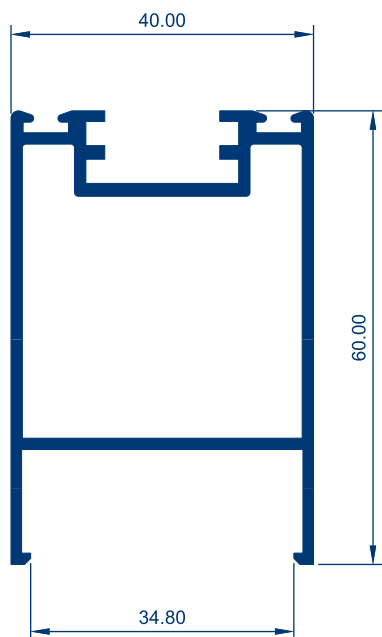

Ref.5111

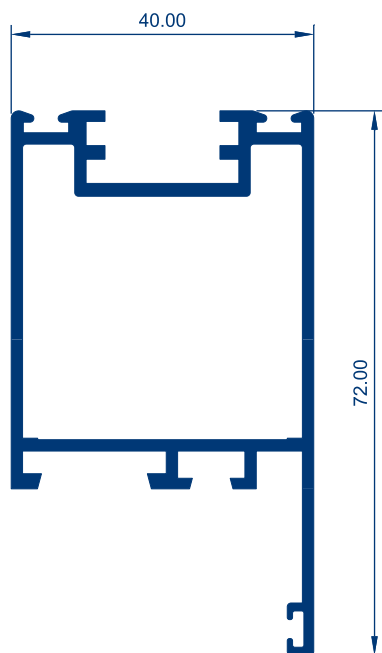

Ref.5334

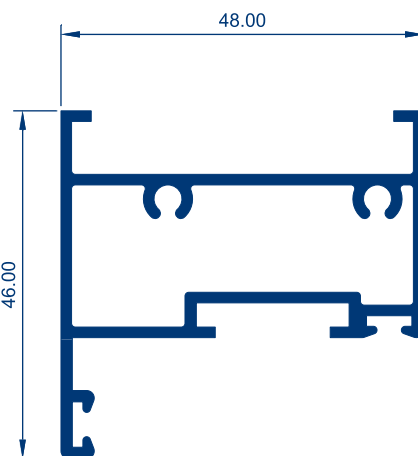

Ref.5335

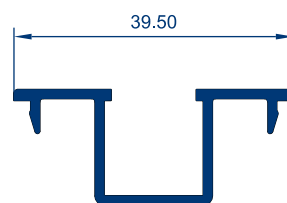

Ref.5070

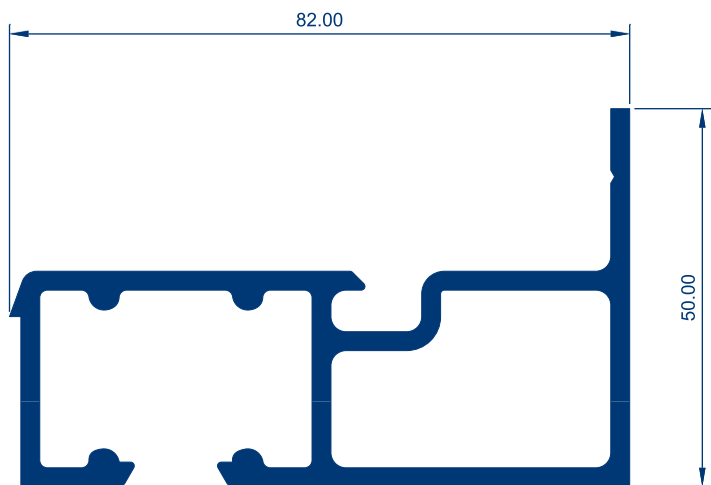

Ref.5340

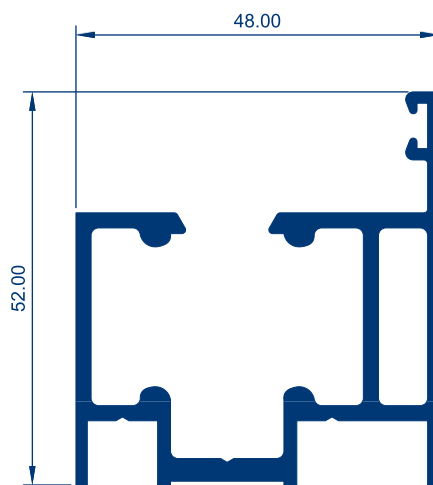

Ref.5336

DOMO MALLORQUINA



SISTEMA MALLORQUINA

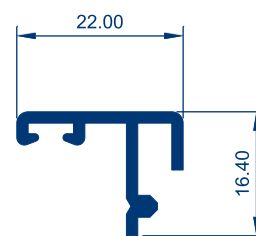
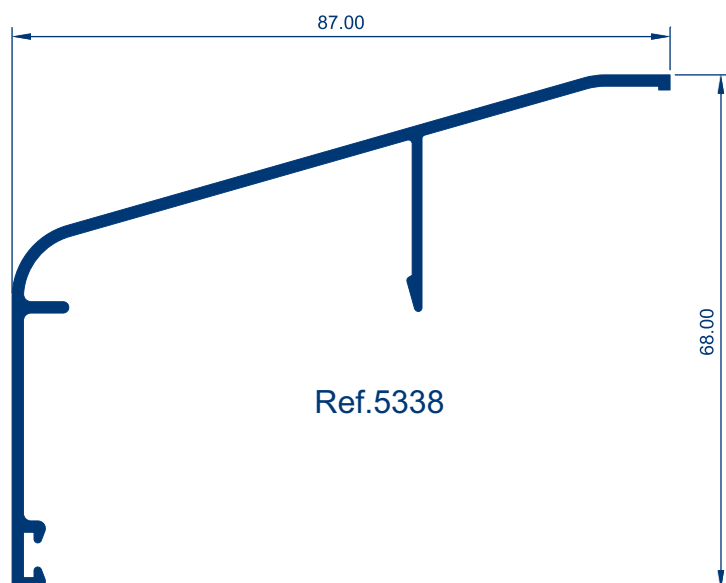

Ref.5337

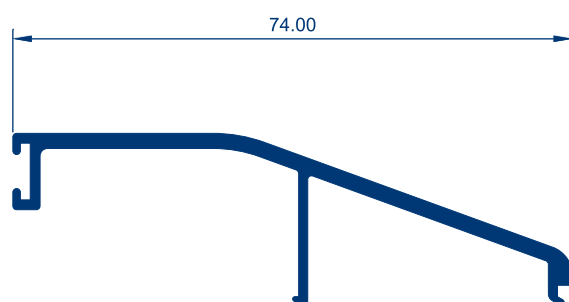

Ref.5341

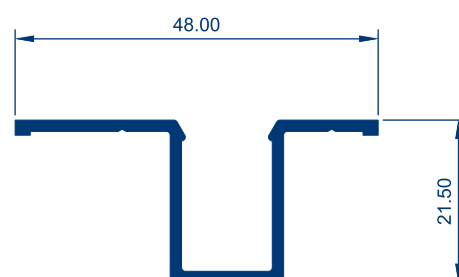

Ref.5342

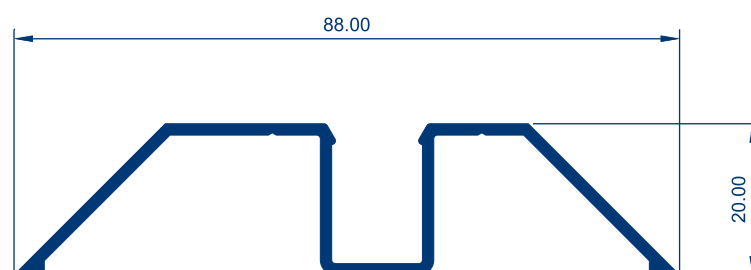

Ref.5343



DOMO MALLORQUINA

SISTEMA MALLORQUINA

Ventana 1 hoja

L+50

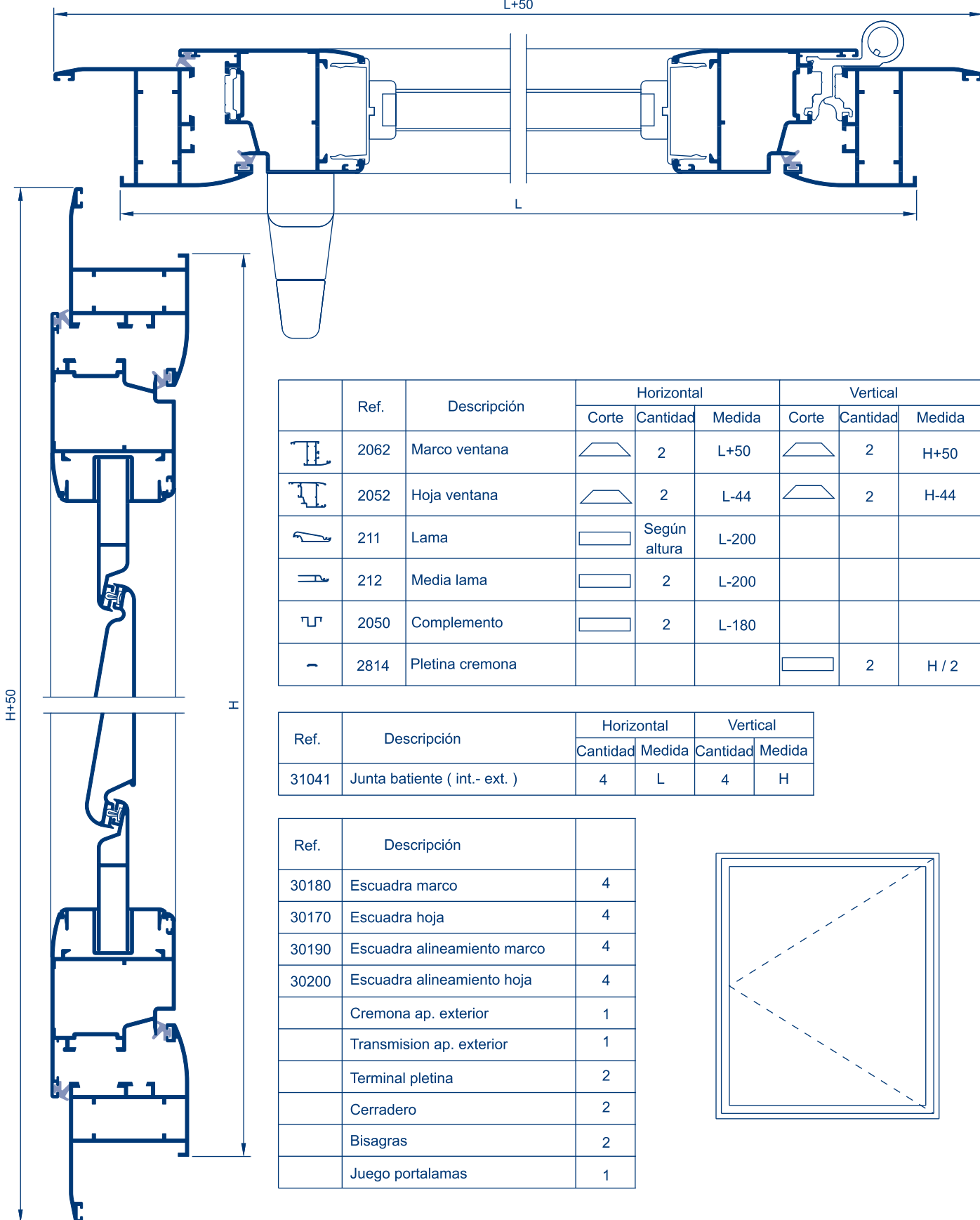

	Ref.	Descripción	Horizontal			Vertical		
			Corte	Cantidad	Medida	Corte	Cantidad	Medida
	2062	Marco ventana		2	L+50		2	H+50
	2052	Hoja ventana		2	L-44		2	H-44
	211	Lama		Según altura	L-200			
	212	Media lama		2	L-200			
	2050	Complemento		2	L-180			
	2814	Pletina cremona					2	H / 2

Ref.	Descripción	Horizontal		Vertical	
		Cantidad	Medida	Cantidad	Medida
31041	Junta batiente (int.- ext.)	4	L	4	H

Ref.	Descripción	
30180	Escuadra marco	4
30170	Escuadra hoja	4
30190	Escuadra alineamiento marco	4
30200	Escuadra alineamiento hoja	4
	Cremona ap. exterior	1
	Transmision ap. exterior	1
	Terminal pletina	2
	Cerradero	2
	Bisagras	2
	Juego portalamas	1

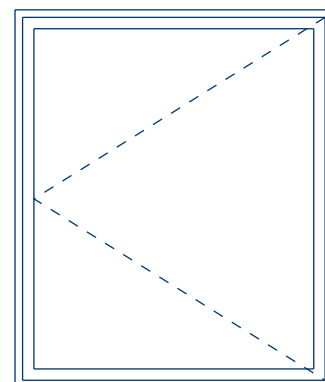

DOMO MALLORQUINA



SISTEMA MALLORQUINA

Ventana 2 hojas

L+50

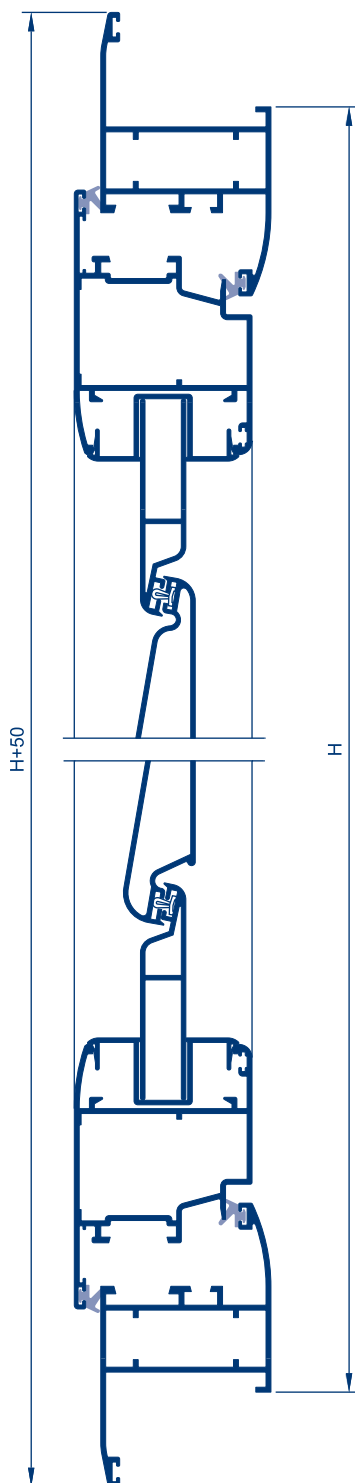
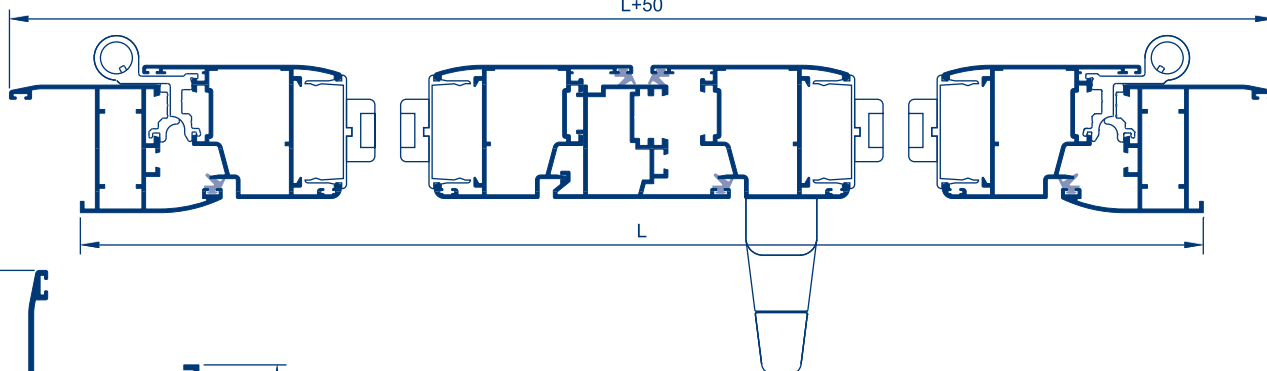

	Ref.	Descripción	Horizontal			Vertical		
			Corte	Cantidad	Medida	Corte	Cantidad	Medida
	2062	Marco ventana		2	L+50		2	H+50
	2052	Hoja ventana		4	L/2 - 25		4	H-44
	2047	Inversor					1	H - 113
	211	Lama		Según altura	L/2 - 181			
	212	Media lama		2	L/2 - 181			
	2050	Complemento		2	L/2 - 165			
	2814	Pletina cremona					2	H / 2

Ref.	Descripción	Horizontal		Vertical	
		Cantidad	Medida	Cantidad	Medida
31041	Junta batiente (int.- ext.)	4	L	7	H

Ref.	Descripción	
30180	Escuadra marco	4
30170	Escuadra hoja	8
30190	Escuadra alineamiento marco	4
30200	Escuadra alineamiento hoja	8
30440	Juego tapas inversor	1
	Cremona ap. exterior	1
	Transmision ap. exterior	1
	Terminal pletina	2
	Cerradero	2
	Bisagras	4
	Juego portalamas	2

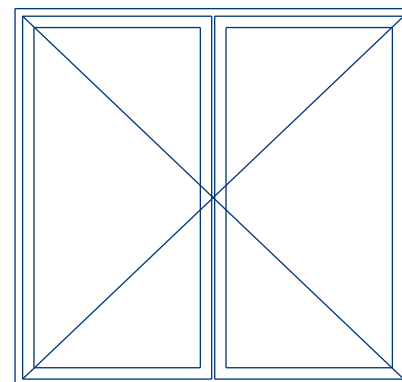



DOMO MALLORQUINA

SISTEMA MALLORQUINA

Puerta 3 hojas

L+50

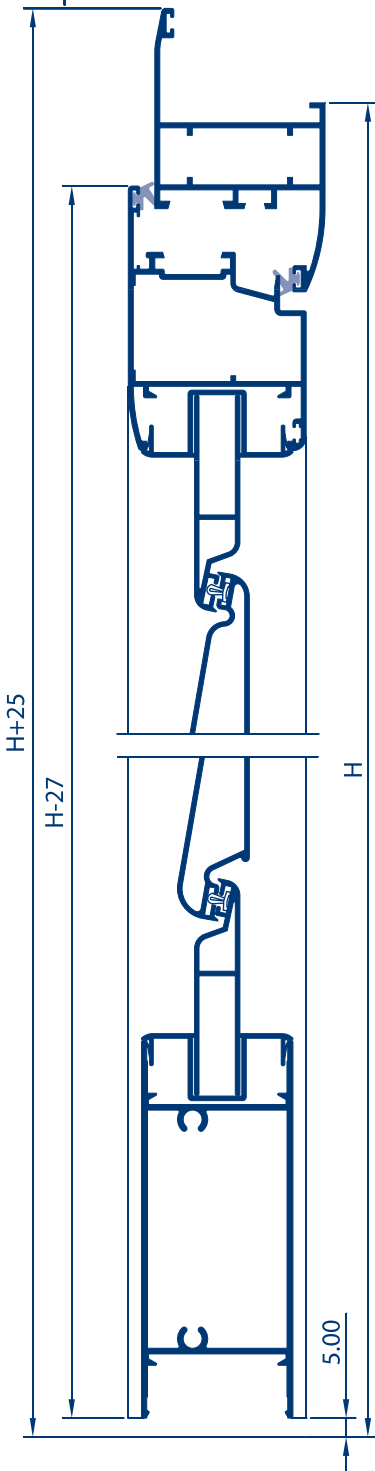
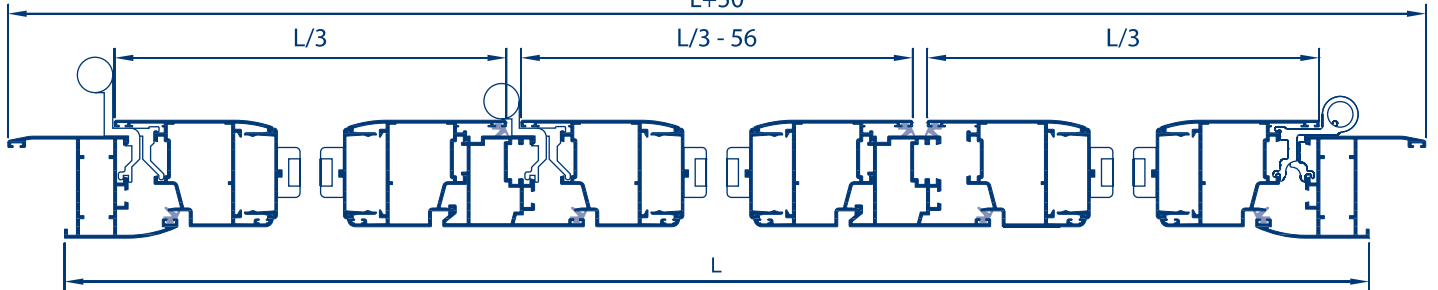

	Ref.	Descripción	Horizontal			Vertical		
			Corte	Cantidad	Medida	Corte	Cantidad	Medida
	2062	Marco ventana		2	L+50		2	H+50
	2052	Hoja lateral ventana Hoja central ventana		4 2	L/3 L/3 - 56		6	H-44
	2047	Inversor					2	H - 113
	211	Lama		Según altura	L/2 - 181			
	212	Media lama		2	L/2 - 181			
	2050	Complemento		2	L/2 - 165			
	2814	Pletina cremona					2	H / 2

Ref.	Descripción	Horizontal		Vertical	
		Cantidad	Medida	Cantidad	Medida
31041	Junta batiente (int.- ext.)	4	L	7	H

Ref.	Descripción	
30180	Escuadra marco	4
30170	Escuadra hoja	8
30190	Escuadra alineamiento marco	4
30200	Escuadra alineamiento hoja	8
30440	Juego tapas inversor	1
	Cremona ap. exterior	1
	Transmision ap. exterior	1
	Terminal pletina	2
	Cerradero	2
	Bisagras	4
	Juego portalamas	2

