

INDALSU

DOMO 67 RT
Rotura de puente térmico

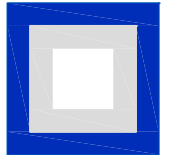

SISTEMAS
CREATIVOS

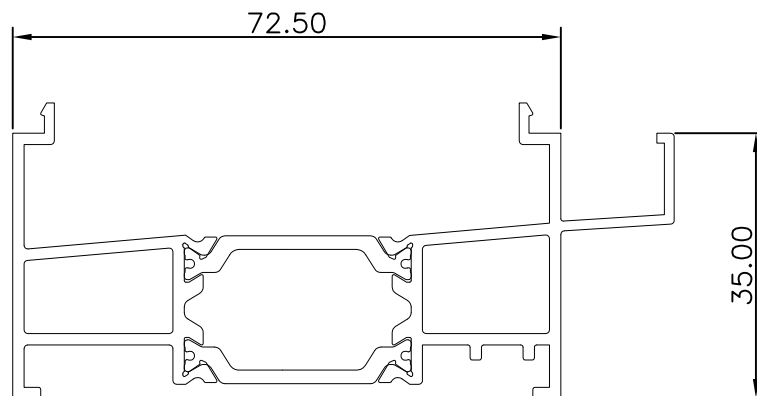

Ref. 3694

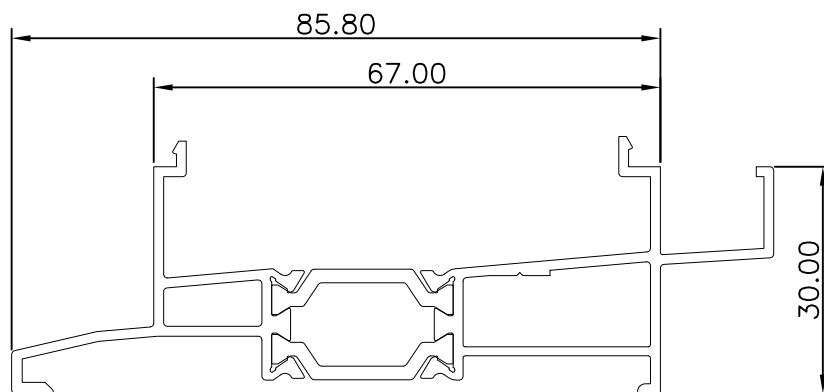

Ref. 3693

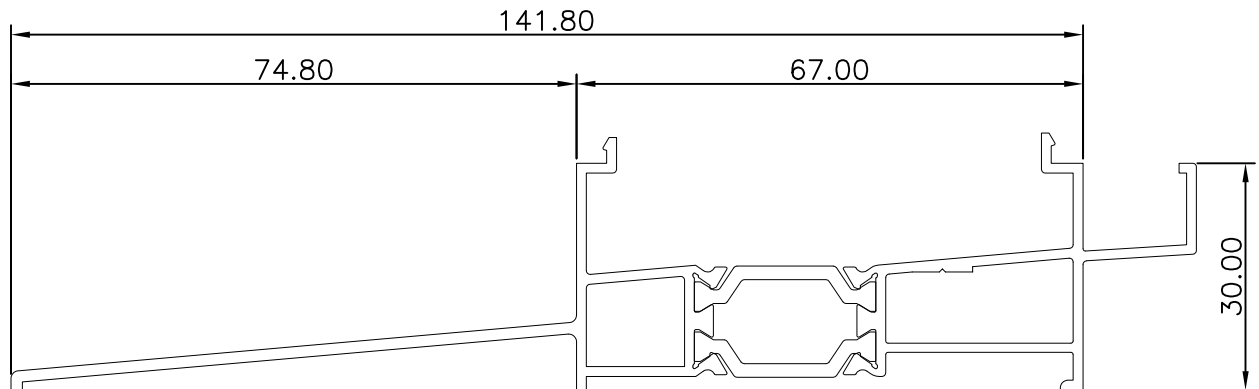
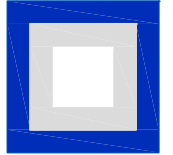

Ref. 3695

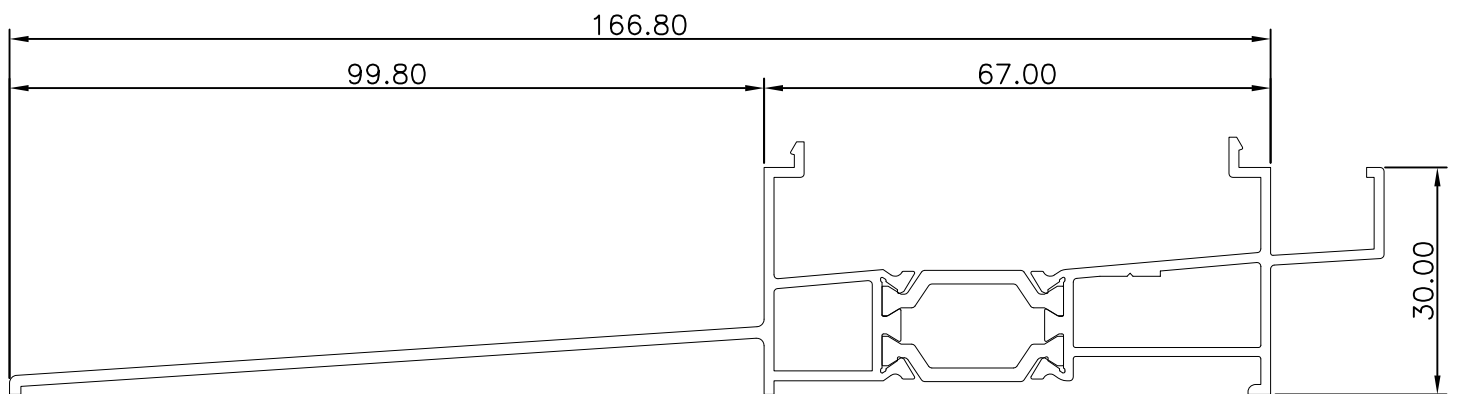

Ref. 3697

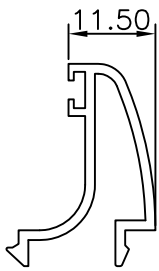
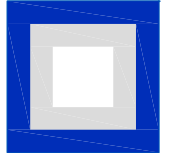

2801

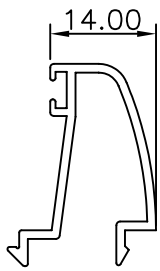

2802

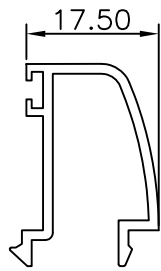

2803

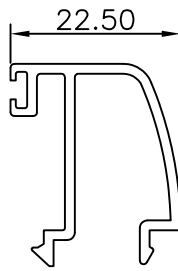

2804

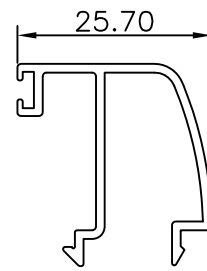

2824

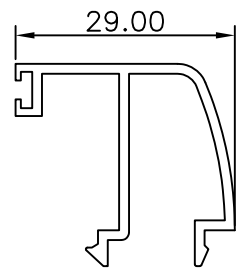

2805

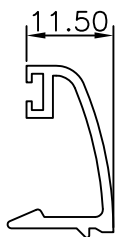

2811

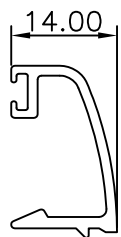

2821

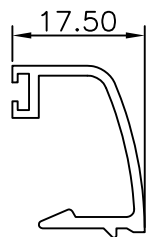

2819

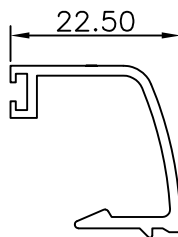

2820

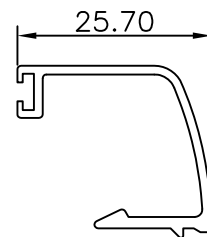

2825

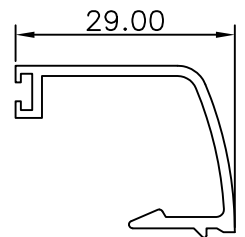

2822

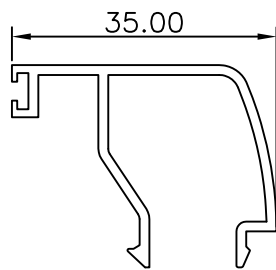

2813

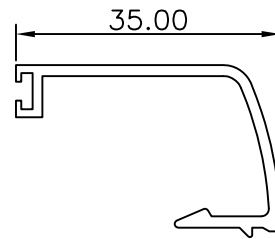

2823

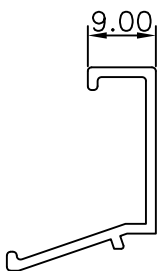

2826

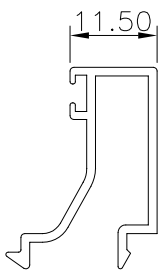

2806

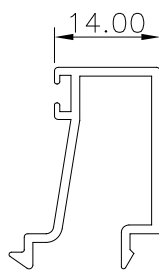

2807

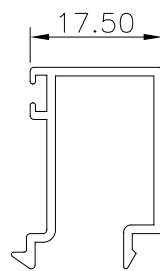

2808

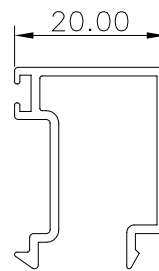

2882

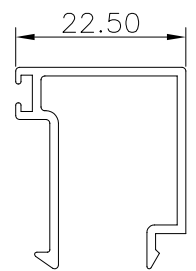

2809

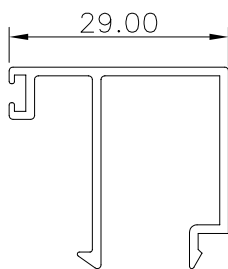

2810

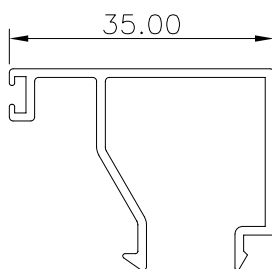

2812

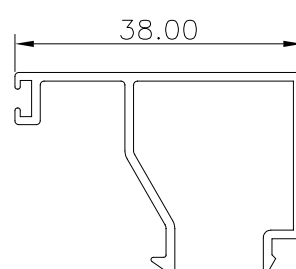

2827

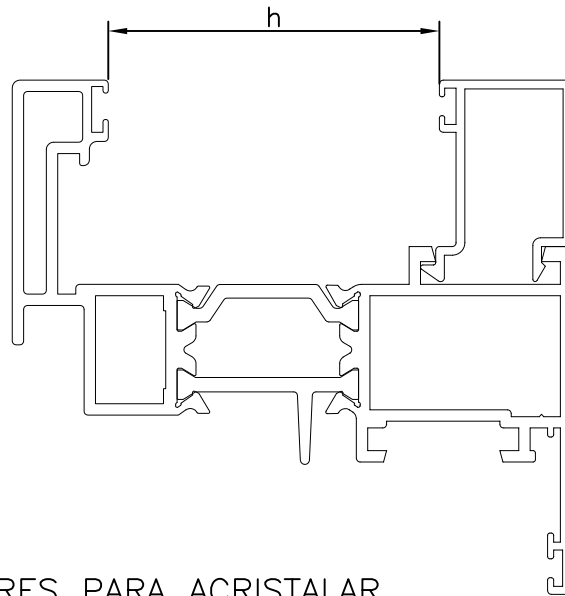
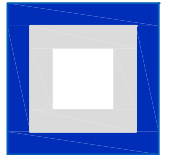

HUECOS LIBRES PARA ACRISTALAR

Junquillo			Hueco (h)
recto	2826	(9.0mm)	52 mm
curvo	2801	(11.5mm)	49 mm
recto	2806	(11.5mm)	49 mm
curvo	2802	(14mm)	47 mm
recto	2807	(14mm)	47 mm
curvo	2803	(17.5mm)	43 mm
recto	2808	(17.5mm)	43 mm
recto	2882	(20.0mm)	41 mm
curvo	2804	(22.5mm)	38 mm
recto	2809	(22.5mm)	38 mm
curvo	2824	(26mm)	35 mm
curvo	2805	(29mm)	32 mm
recto	2810	(29mm)	32 mm
curvo	2813	(35mm)	26 mm
recto	2812	(35mm)	26 mm
recto	2827	(38mm)	23 mm

Junquillos grapa para junquillos curvos

Junquillos curvos

2801	2802	2803	2804	2824	2805	2813
2811	2821	2819	2820	2825	2822	2823

Junquillos grapa